

GOOD PRACTICES IN REFRIGERATION

GUIDELINE FOR REF & AC SERVICE TECHNICIANS



MINISTRY OF ENVIRONMENT

Air Resource Management and National Ozone Unit

Good Practices in Refrigeration-Guidelines for Refrigeration and Air conditioning workshops.

Copy right : Ministry of Environment.
All Rights Reserved

Year : 2020

Published by : Air Resource and National Ozone Unit of Ministry of Environment, Sri Lanka

Printed by : Thewani Printers
05, Meegahawatta Road, Gangodawila, Nugegoda.
Tel: 0773 320604, 0776 939725

**GOOD PRACTICES IN REFRIGERATION
TABLE OF CONTENT**

CHAPTER 1 - REFRIGERATION

- 1.1 Refrigeration System
- 1.2 Refrigerations
- 1.3 Refrigerant Oil

CHAPTER 2 - ROOM AIR CONDITIONERS

- 2.1 Installation of room Air Conditioners

CHAPTER 3 - SERVICES

- 3.1 Refrigerant Recovery
- 3.2 Recovery machine assembly
- 3.3 Good Practices in Refrigeration
- 3.4 Toole and Equipment

Tools & Equipment for Servicing & Repair

Quick Test Board

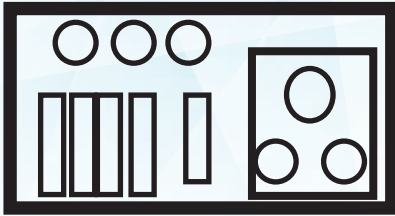

Test Terminals



Digital Clamp Meter
(Multi function)



Digital Thermometer with
puncture probe



Ratchet wrench / Service valve
wrench



Wire Stripper



Lock Ring Tool Set

Lock Ring Accessories

Igniter



Piercing Pliers / Valve



Pinch Off Pliers / Self-

locking Pliers



Piercing Pliers / Valve



Tube Cutter



Deburring Tool



Capillary Tube Cutter



Tube Bender

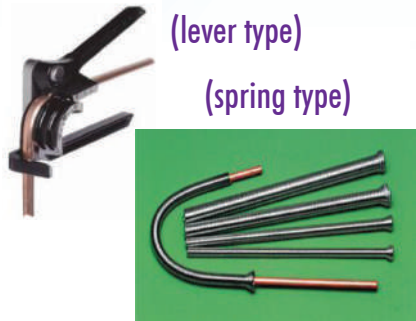

Flaring Combination



locking Pliers

Expander



Gauge Manifold – 2 way

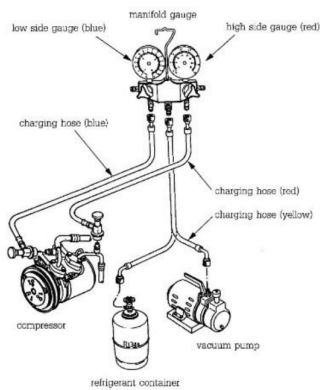
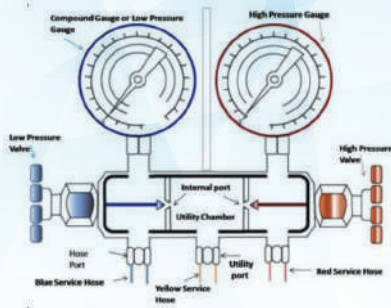



Manifold – 4 way



- 1- Low side connection
- 2- Low side valve
- 3- Low side compound gauge
- 4- High side connection
- 5- High side valve
- 6- High side pressure gauge
- 7- Vacuum pump valve
- 8- Vacuum gauge isolating valve
- 9- Vacuum gauge
- 10- Charging valve

Use separate Evacuation & Charging (E&C)

<p>Brazing Equipment</p>	<p>Refrigerant Recovery machine with a Recovery cylinder</p>	<p>Portable Evacuation & Gas Charging Station with weighing scale</p>
		

Vapor compression refrigeration Thermodynamic process Temperature

Heat

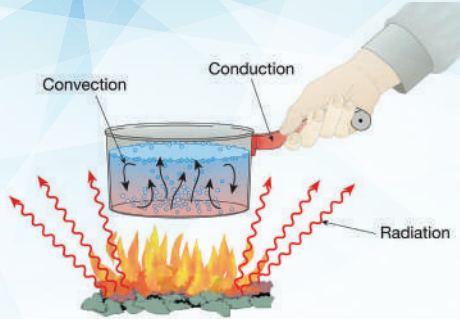

Temperature Scale Conversions

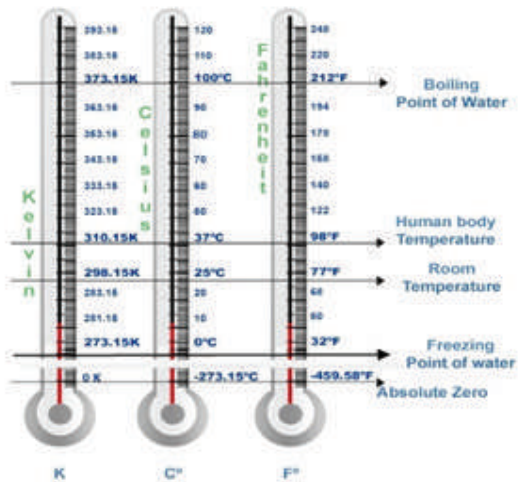

Heat Transfer



All refrigeration systems work by transferring heat around, moving it from a designated area to somewhere else. However, there are different types of refrigeration systems. The most widely used refrigeration cycle method is mechanical compression (Vapour compression refrigeration). It has applications in both Refrigeration and air conditioning system with house hold, commercial, marine, ,Transportation and industrial etc.

The Vapour compression refrigeration cycle

The refrigeration cycle follows the same principle for all applications in the different subsectors. Refrigerants are substances that absorb or release latent heat during a phase change (vapour to liquid and back). During the phase change from liquid to vapour, the heat is absorbed. This happens when the pressurised liquid refrigerant expands from the expansion device in the low pressure evaporator, which is a form of heat exchanger. Air or another medium is cooled at the evaporator's surface when the heat of the medium is absorbed. To prepare the refrigerant for the next cooling cycle, a compressor pressurises the refrigerant to a dense vapour, which then undergoes a phase change from vapour to liquid in the condenser. During this process, the refrigerant releases heat, which is transported outside the space that needs cooling. The heat transfer is supported through a heat exchanger. Electrical fans blow air over the evaporator and condenser to enhance the heat exchange.

Different applications require changes to the basic design, some of which are illustrated by the following examples: In cars and trucks the power to operate the compressor often comes directly from the engine. In chillers, water is cooled at the evaporator's surface instead of air, and can then be distributed over longer distances, for example in large office buildings.

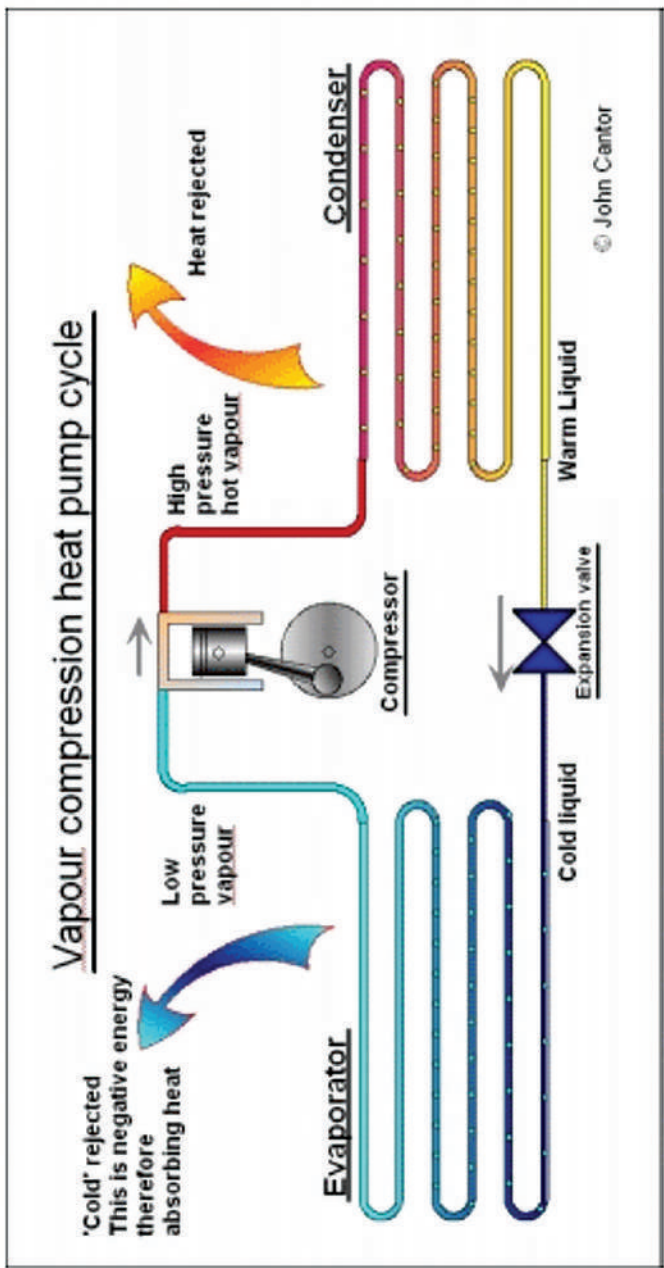

-
- **Compressor** — Changes a low-pressure vapor to a high-pressure vapor. The common types of room air-conditioners have small hermetic reciprocating or rotary, and in select cases scroll compressors.
 - **Condenser** — Changes a high-pressure vapor to a high-pressure liquid by rejecting heat from the refrigerant causing the refrigerant to condense.
 - **Expansion device or Capillary** — Decreases the pressure to lower the saturation temperature and allow the refrigerant to evaporate or boil in the evaporator/cooling coil. In room air-conditioners it is capillary that acts as expansion device.
 - **Evaporator** — Changes (boils) the low-pressure two-phase mixture of liquid and vapor refrigerant into an all-vapor stream of refrigerant, drawing heat into the refrigerant (thus providing cooling) during
-
-

Super-heating and Sub cooling

Sub-cooling

The difference between the condensing temperature and the temperature of the liquid at the outlet of the condenser is sub-cooling.

Super heat

The difference between the evaporating temperature and the temperature of the gas at the outlet of the evaporator super heat.

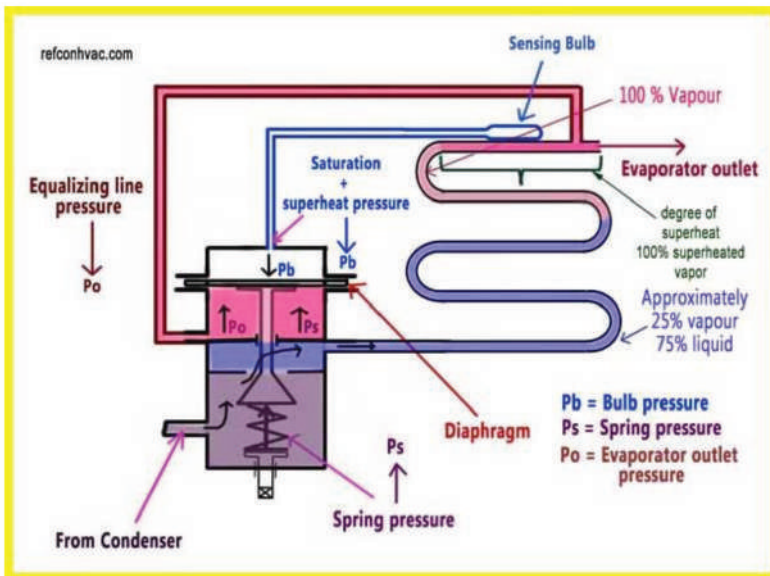

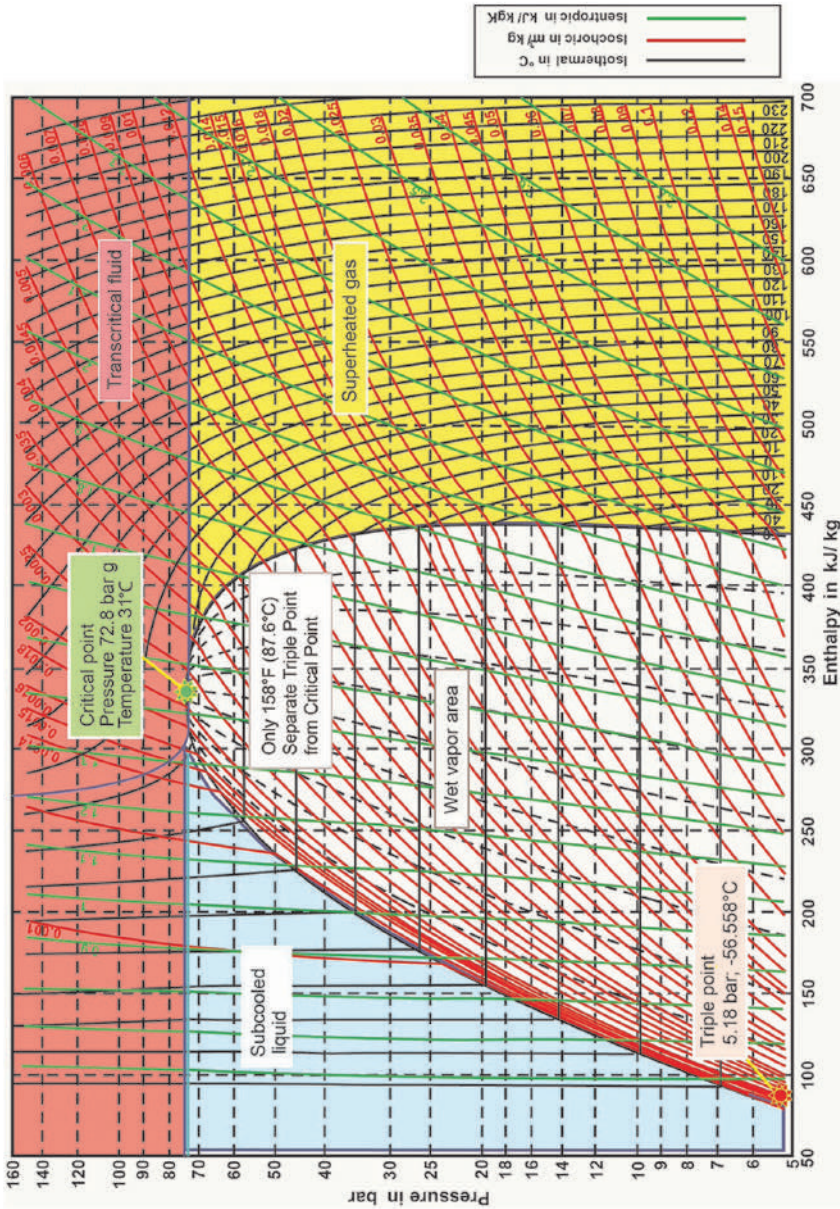

P-h diagram for vapor compression cycle (R134a)

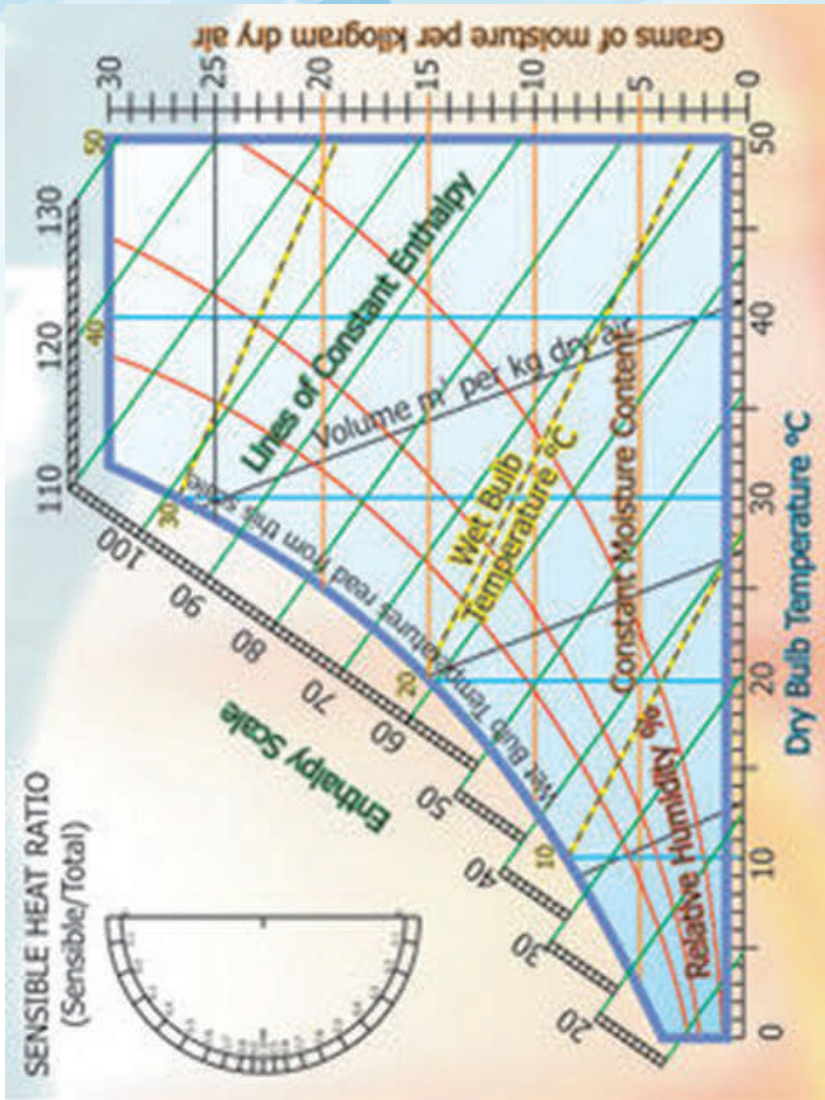

Psychrometric chart

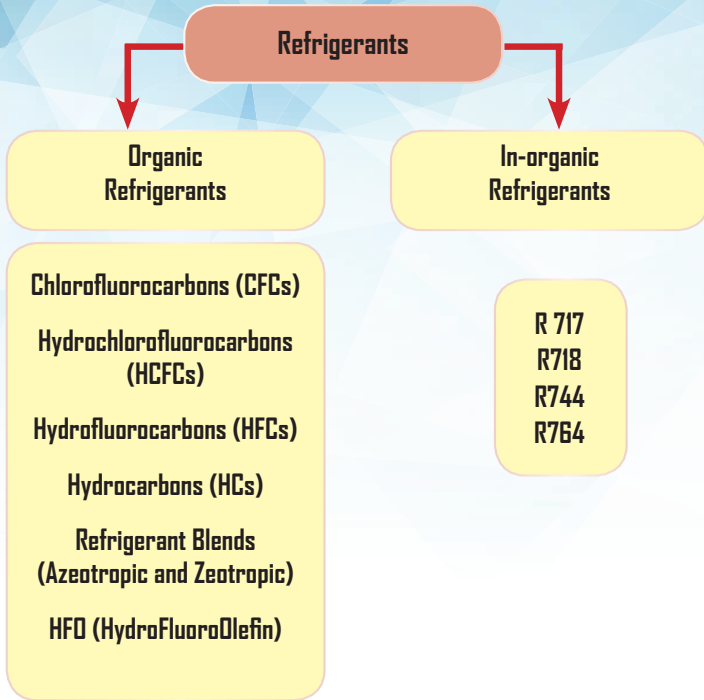

Consideration for the Refrigerants

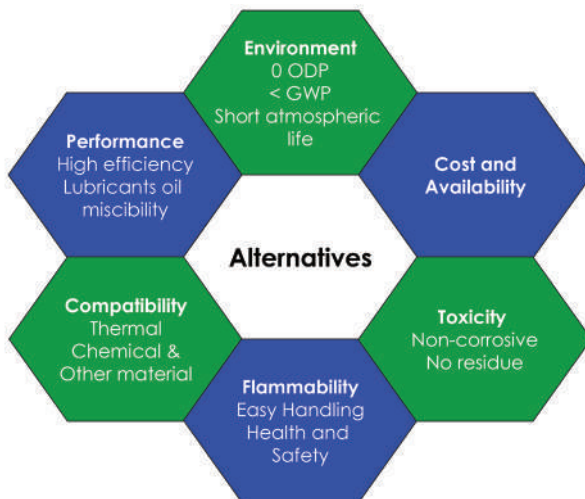

Environmental Characteristics

Refrigerant		Atmospheric Lifetime (Years)	Ozone Depletion Potential (ODP)	Global Warming Potential (GWP) (100 Year)
CFC (no more)	CFC-11 (Baseline ODP)	50	1	4000
	CFC-12	102	1	10900
HCFCs	HCFC-22	13.3	0.055	1820
	HCFC-123	1.4	0.02	93
	HCFC-141b	9.4	0.11	630
	HFC-134a	14.6	0	1300
HFCs	HFC-245fa	7.3	0	820
	R-32	-	0	675
HCs	HC-290 (Propane)	-	0	3
	R-1270 (Propylene)	-	0	<2
	R-404A	-	0	3260
HFC Blends	R-407A	-	0	1770
	R-407C	-	0	1530
	R-410A	-	0	1730
Ammonia	R-717	-	0	<1
CO2	R-744	-	0	1
HFOs	1234yf, 1234ze	-	0	4,7

Hydrocarbons (local safety regulations apply)

Type	R-Number	Chemical formula / common name	ODP	GWP 100yr	Safety group
HC	R-1150	CH ₂ =CH ₂ - ethylene	0		A3
HC	R-1270	CH ₃ CH=CH ₂ - propylene	0		A3
HC	R-170	CH ₃ CH ₃ - ethane	0		A3
HC	R-290	CH ₃ CH ₂ CH ₃ - propane	0	3	A3
HC	R-600	CH ₃ -CH ₂ -CH ₂ -CH ₃ - butane	0	3	A3
HC	R-600a	CH(CH ₃) ₂ -CH ₃ - isobutane	0	3	A3

Hydrocarbon Blends (local safety regulations apply)

Type	R-Number	Chemical formula / common name	ODP	GWP 100yr	Safety group
HC Blend	R-432A	R-1270/E170 (80.0/20.0)			A3
HC Blend	R-433A	R-1270/290 (30.0/70.0)			A3
HC Blend	R-436A	R-290/600a (56.0/44.0)			A3
HC Blend	R-436B	R-290/600a (52.0/48.0)			A3
HC Blend	R-510A	R-E170/600a (88.0/12.0)			A3

Natural Refrigerants (local safety regulations apply)

Type	R-Number	Chemical formula / common name	ODP	GWP 100yr	Safety group
Natural	R-702	H ₂ - normal hydrogen	0		A3
Natural	R-704	He - helium	0		A1
Natural	R-717	NH ₃ - ammonia	0	0	B2
Natural	R-718	H ₂ O - water	0	0	A1
Natural	R-729	air - 78% N ₂ , 21% O ₂ , 1% Ar, +	0	-	A1
Natural	R-744	CO ₂ - carbon dioxide	0	1	A1
Natural	R-764	SO ₂ - sulfur dioxide	0	300	B1

Refrigerants Options

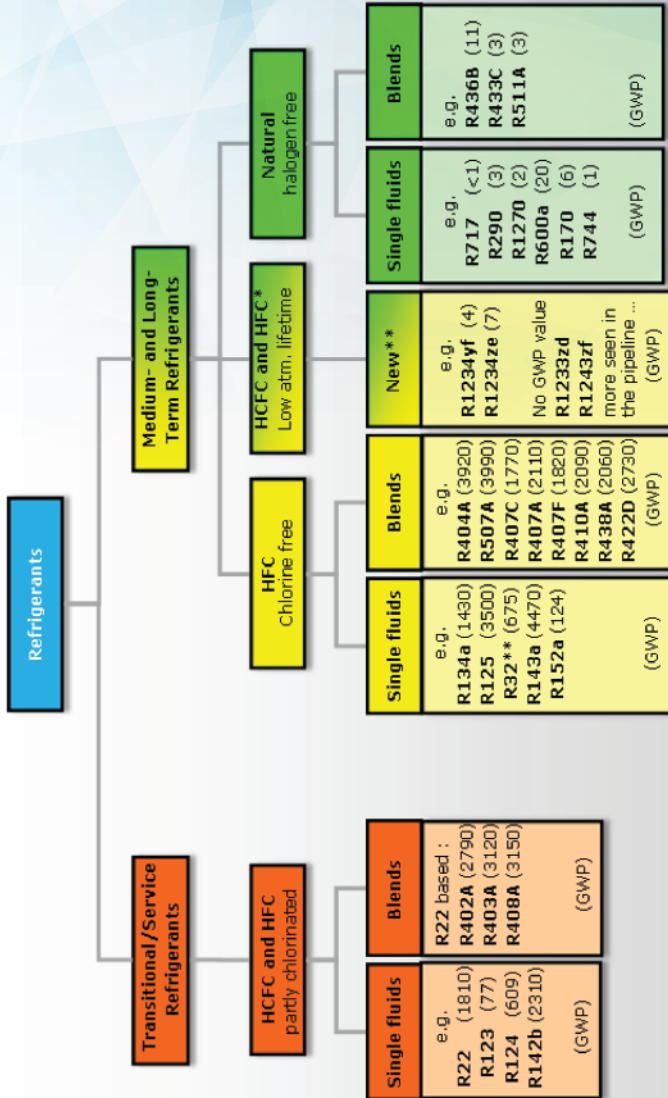

* Also called HFO. Molecules contain weak double bonds causing a fast breakdown in the atmosphere
 ** R32 (HFC) and many of the new refrigerants are flammable or mildly flammable. Natural refr. are mainly flammable except R744.

HFC Blend - Azeotropic

**SINGLE COMPONENT
PRESSURE - TEMPERATURE CHART**

LENGTH OF HEAT EXCHANGER

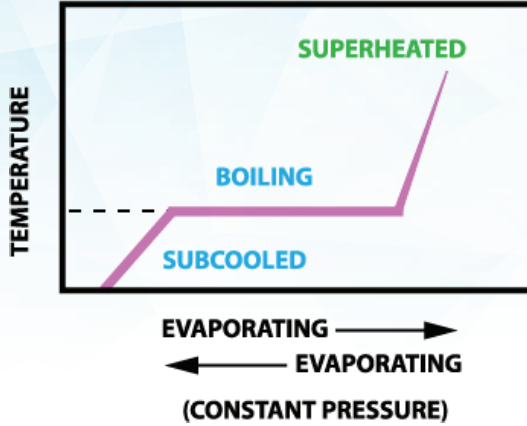

HFC Blend - zeotropic

**ZEOTROPIC BLEND
PRESSURE - TEMPERATURE CHART**

LENGTH OF HEAT EXCHANGER

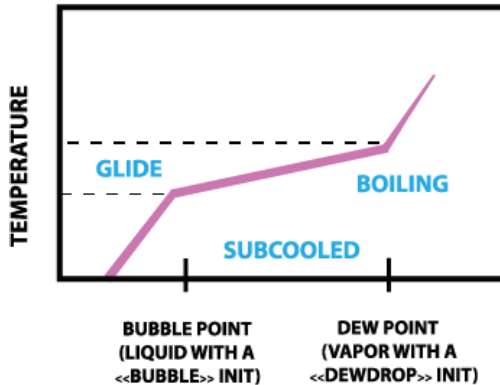

HFCs – possibilities

- ☛ **R-407C as a substitute to HCFC-22**
 - Retrofit possible
- ☛ **R-410A as a substitute to HCFC-22**
 - For new systems
 - It has higher pressures
 - It is not recommended as retrofitting refrigerant
- ☛ **R-507A as a substitute to HCFC-22**
 - HFC blend replacement option for R-22 in commercial refrigeration systems.
 - It can be used in new and existing systems, and provides very similar performance over the entire operating range.



Refrigeration Oil and Good properties

Five main categories of refrigeration lubricants

- ☛ Mineral Oils (MO)... HCFC
- ☛ Alkyl Benzene Oils (AB)...HCFC
- ☛ Polyol Ester Oil (POE)... synthetic
- ☛ Poly Alpha Olefin Oils (PAO) ...synthetic
- ☛ Poly Alkyl Glycol Oils (PAG)... synthetic

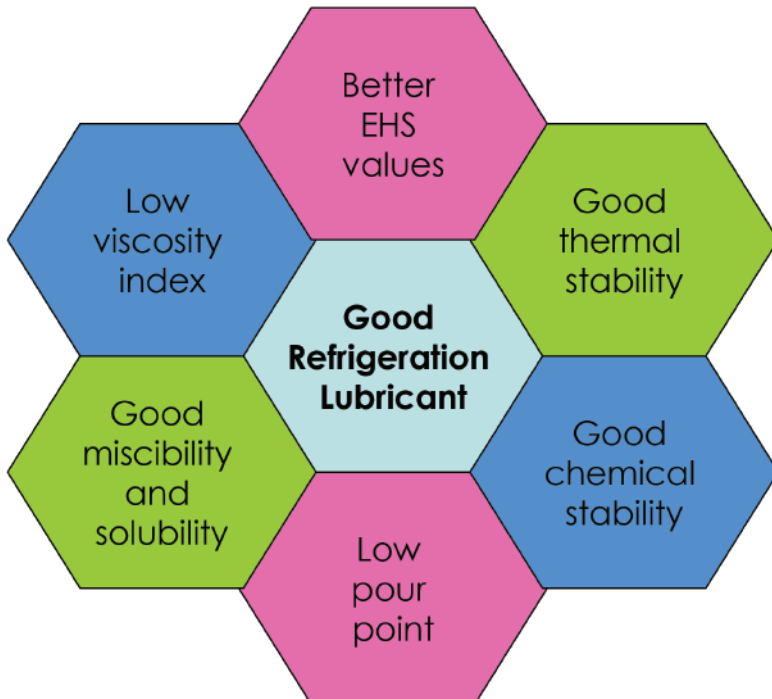

Appropriate Lubricant

Refrigerant	Appropriate Lubricant				
	Mineral Oil (MO)	Alkyl benzene (AB)	Polyol Ester (POE)	Poly alpha olefin (PAO)	Poly alkyl glycol (PAG)
CFC-11	✓	✗	□	□	✗
CFC-12	✓	✓	□	□	✗
R-502	✓	✓	□	□	✗
HCFC-22	✓	✓	□	□	✗
HCFC-123	✓	✓	□	□	✗
HFC-134a	✗	✗	✓	✗	□
HFC-404A	✗	✗	✓	✗	□
HFC-407C	✗	✗	✓	✗	□
HFC-410A	✗	✗	✓	✗	□
HFC-507A	✗	✗	✓	✗	□
HC-600a	✓	□	✓	✓	□
HC-290	✓	□	✓	✓	□
R-717 (NH ₃)	✓	□	✗	✓	□
R-744 (CO ₂)	□	□	✓	✓	✓

✓: Good Suitability □: Application with limitations ✗: Not Suitable

Issues with Alternative Refrigerants

HFC blends

- ☛ POE lubricants are highly hygroscopic
- ☛ Better manufacturing & servicing practices
- ☛ Training required

Hydrocarbons

- ☛ Require safer design
- ☛ Better manufacturing & service practices
- ☛ Knowledge of legislation, regulation and standards relating to flammable refrigerants;
- ☛ Detailed knowledge of and skill in handling flammable refrigerants including blends, personal protective equipment, refrigerant leakage prevention, handling of cylinders, charging, leak detection, recovery and disposal.
- ☛ Training required

CO₂

- ☛ High pressure refrigerant
- ☛ Better manufacturing & servicing practices
- ☛ Require safer design
- ☛ Training required

Ammonia

- ☛ Require safer design
- ☛ High discharge temperature of ammonia gas
- ☛ Better manufacturing & service practices
- ☛ Training required

Installation procedure of air conditioner window and split

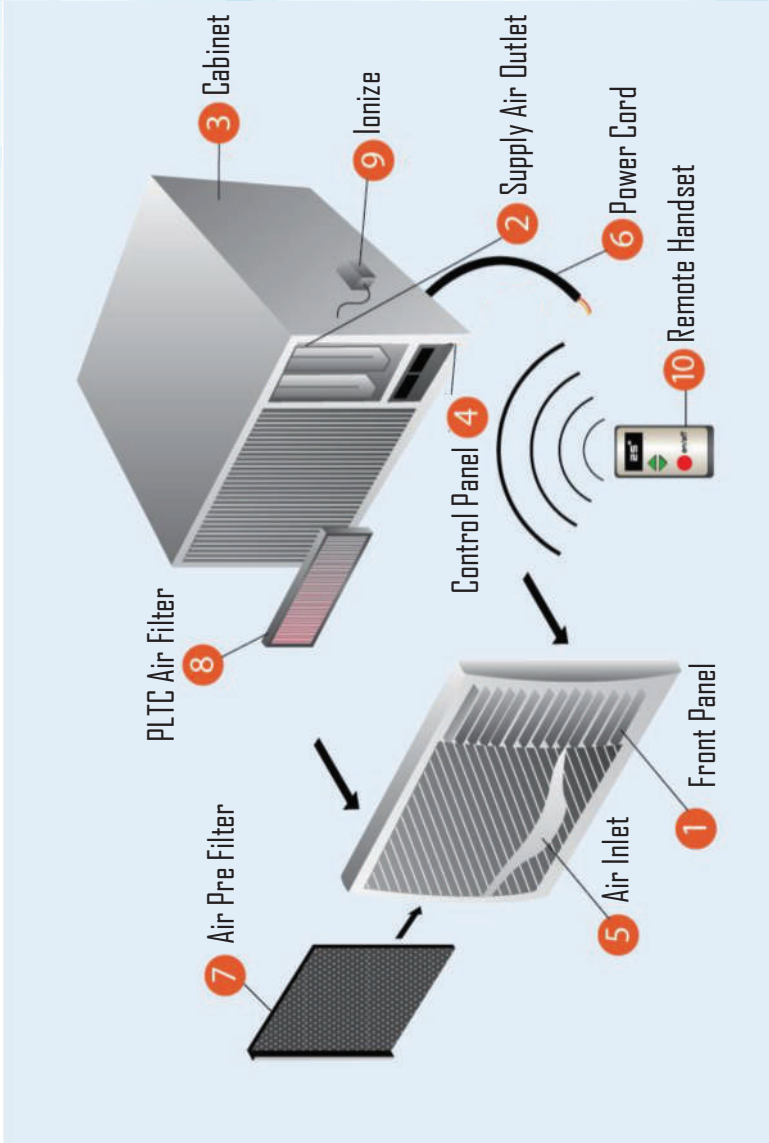

Determine Split Air Conditioner Location – Fan Coil Unit (FCU) air-flow

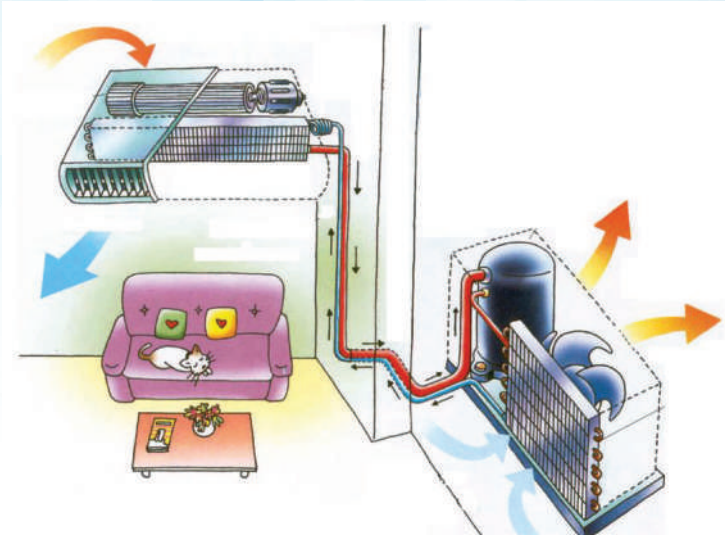

Test Run before Fixing

- ☛ Compressor functioning
- ☛ Fan mounting
- ☛ Motor
- ☛ Blower
- ☛ Alignment
- ☛ Operation of control panel and remote control
- ☛ Cooling
- ☛ Check current

Determine Split Air Conditioner Location – Condensing Unit (CDU) air flow

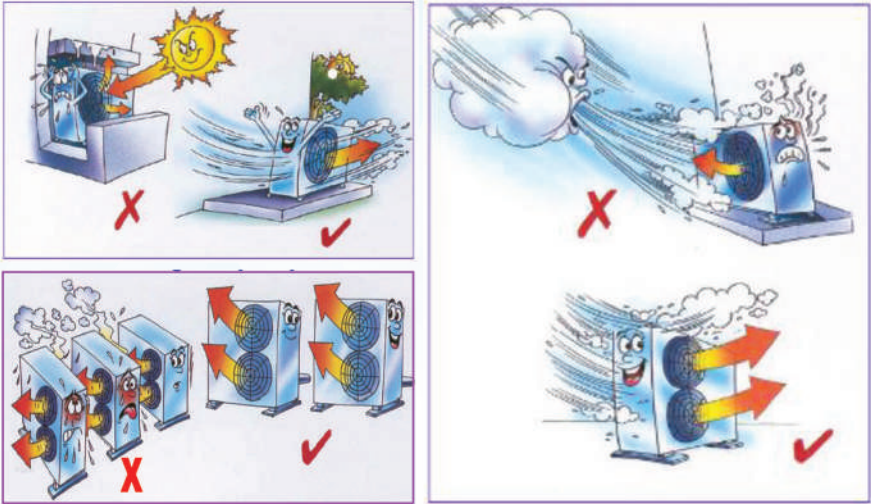

Hot air must not be allowed to flow freely through the adjacent CDU to maintain good efficiency

Determine Split Air Conditioner Location from wall

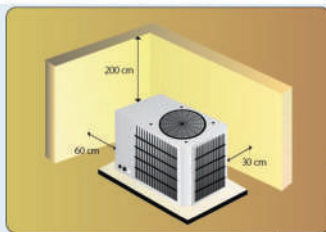

Do not install CDU too close to the wall. It will trip due to high head pressure, as heat dissipation can't happen.

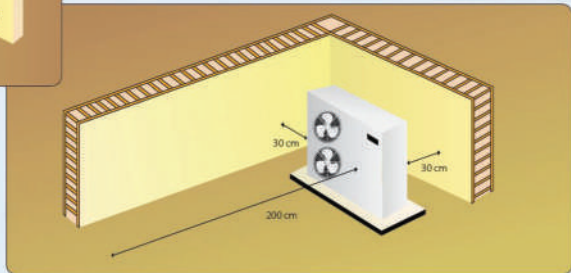

Piping layout for split air-conditioner

1/8 inch per foot (10.4 mm/m) in the direction of refrigerant flow

Wrong methods



Correct method

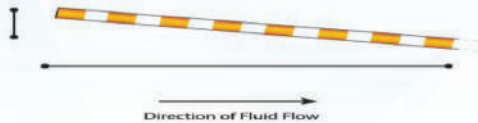

Insulation

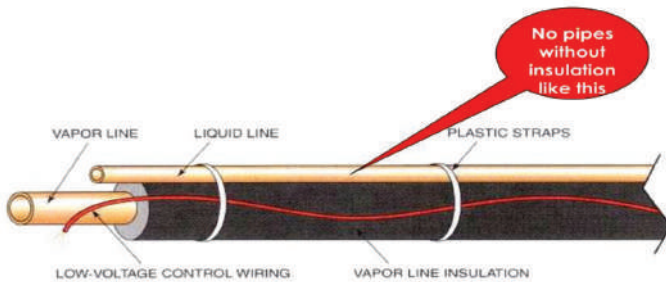

Drainage

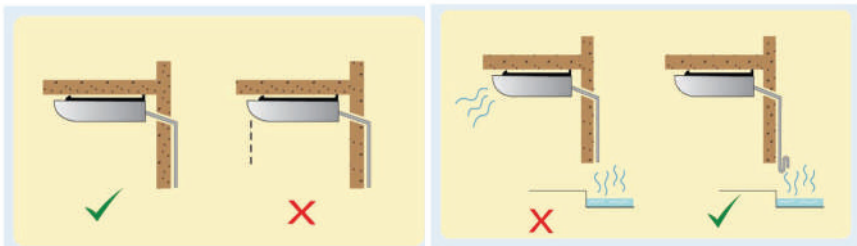

Leak Test with Electronic Leak



Leak Test with Soap solution



Helide Leak Detector

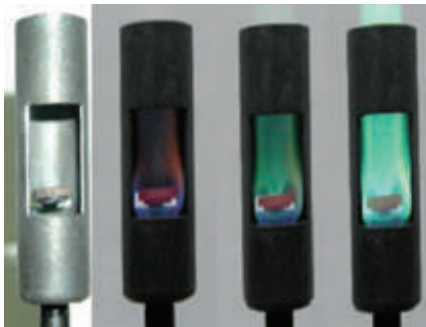

Customer Education Save Energy & Keep AC Healthy



Recovery Machine

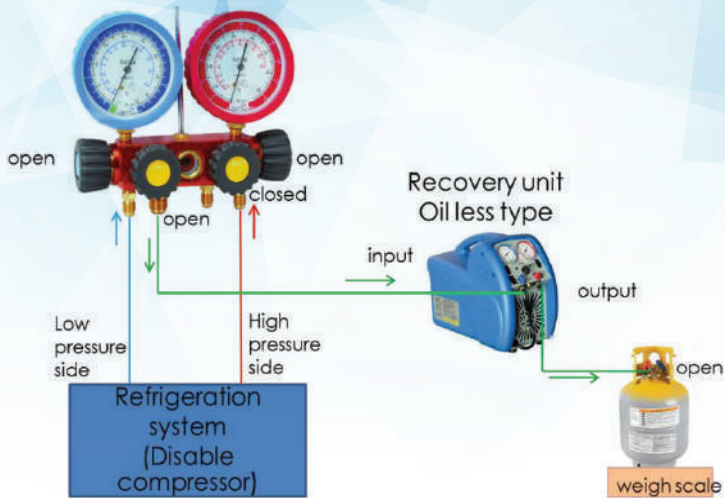

Type of Refrigerant Cylinders

There are two type of cylinders

1. Disposable / non-refillable cylinders
2. Recovery / Refillable cylinders



Recovery Machine Assembly

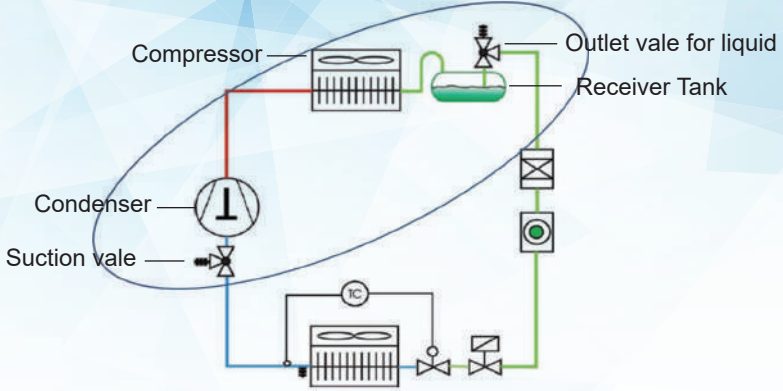

Flow Diagram

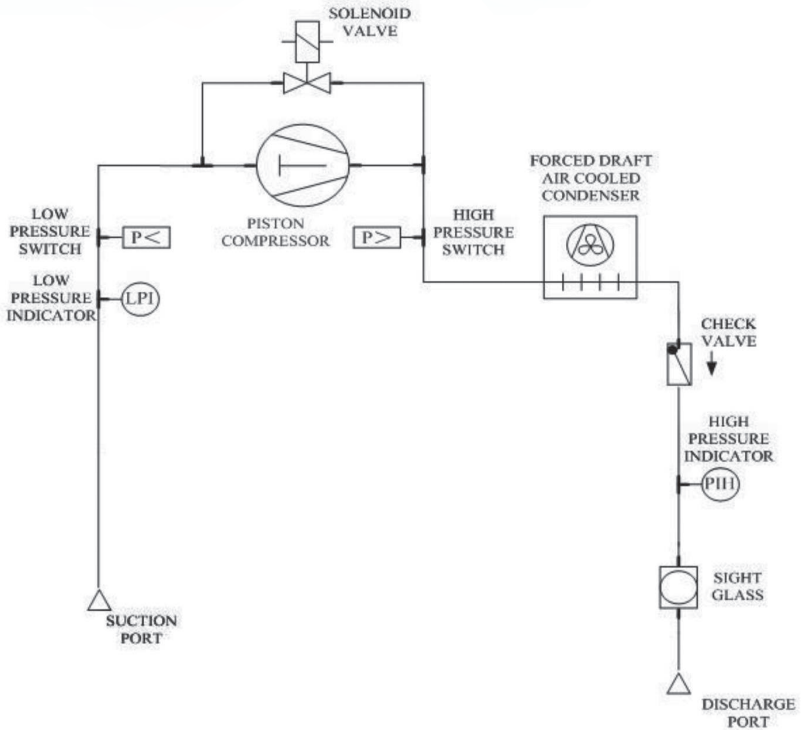

Components needed

- Condensing unit
- Pressure switches
- Shut off valves
- Fittings and piping
- On / off switch
- Drier



Wiring Diagram

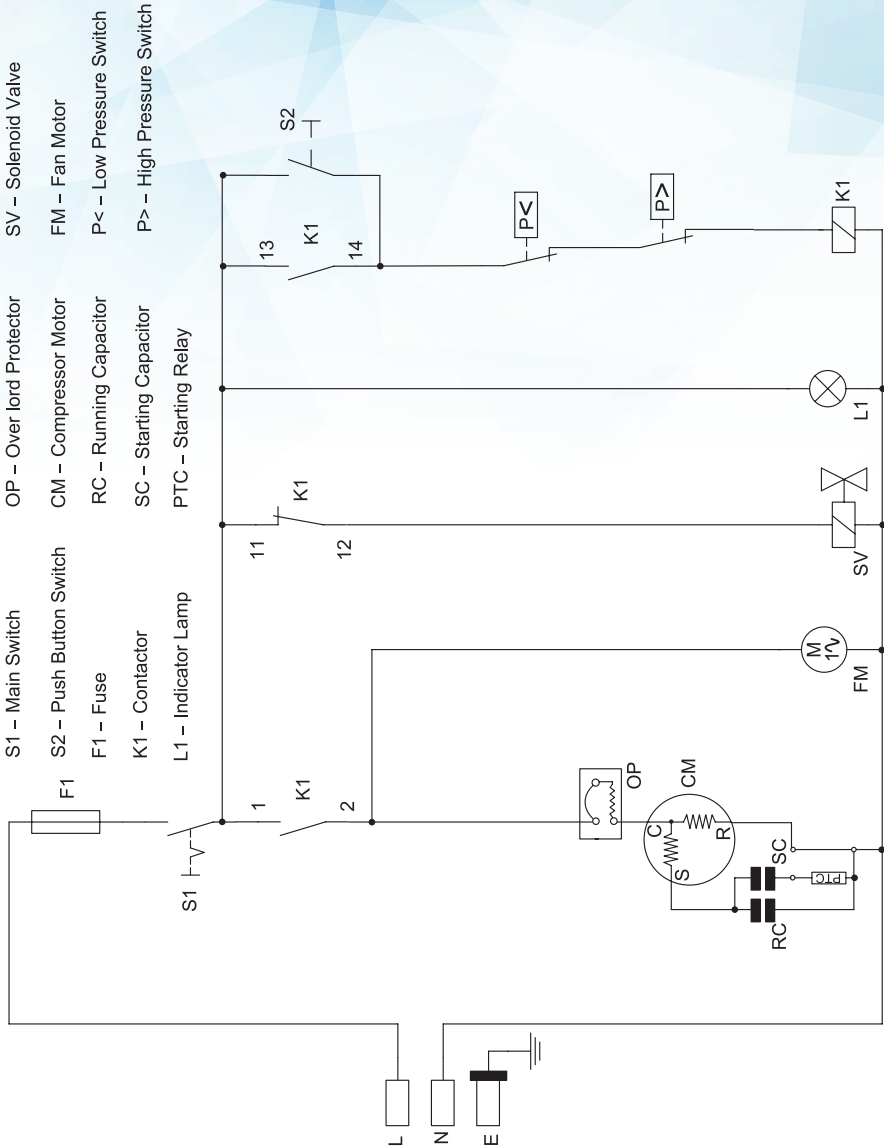

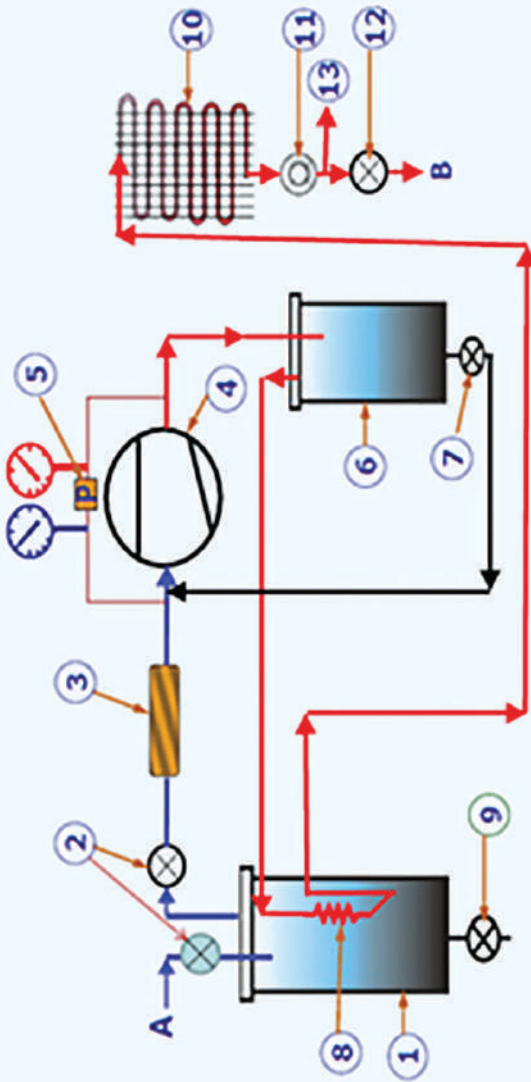

1. Distillator
2. Valves

6. Oil separator
7. Oil drain valve

3. Filter
4. Compressor
5. Pressure control

8. Heat exchanger
9. Access valve
10. Condensing unit

11. Sight glass
12. Valve

13. Entry-suction

Servicing of HCFC/ HFC/ HC Based AIR Conditioners

Steps of Servicing

1. Recovery of Refrigerant
2. Cleaning and flushing
3. Repair
4. Flushing and choke testing
5. Leak Testing
6. Evacuation & Vacuum holding
7. Charging Refrigerant
8. Sealing of process tube
9. Checking for proper Operation

1. Recovery of Refrigerant

- Recover these are ODP & GWP gases
- Use piercing pliers or piercing valve
- Use Recovery machine & a recovery cylinder

Schrader connector

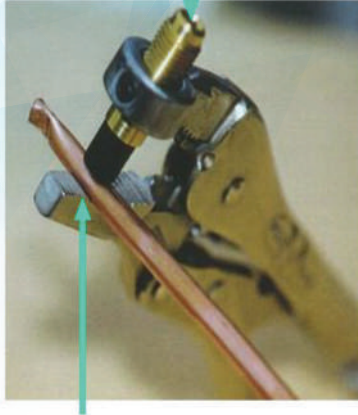

Ensure tight fit



Piercing pin

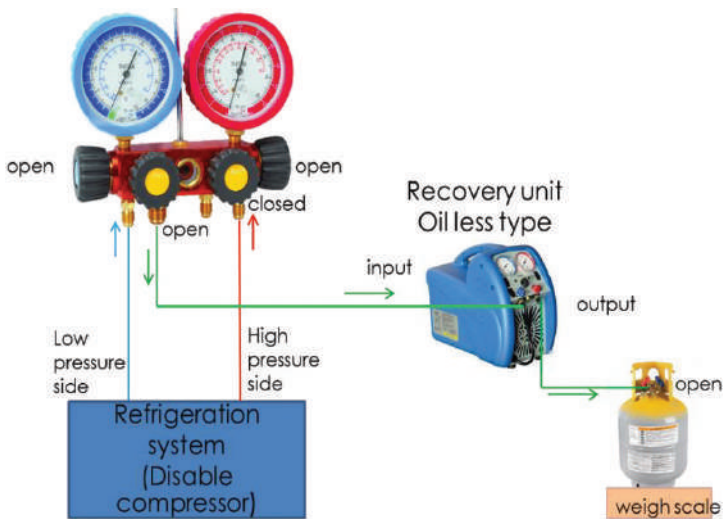

2. Cleaning and flushing

- ☛ Drier must be removed when pressure drop exceeds rated amount
- ☛ After de-brazing of the old filter or drier
 - Use dry Nitrogen with two stage regulator, at a pressure of about 5-10 bar
 - Use ODS free substance where chemical cleaning is required
 - Do not use R141b, CTC, air or petrol

3. Repair

- ☛ Carry out the necessary repair with the system.
- ☛ Change the filter drier in case of medium commercial HFC based appliances.

4. Flushing and choke testing

- ☛ Introduce oxygen free dry nitrogen (OFDN) through the process tube and ensure free passage at the process tube of the double mouth filter drier in case of small commercial appliances and from T joint of window air-conditioner.
- ☛ See the nitrogen coming out of both sides.

5. Leak Testing

- ☛ Pressurize the system to maximum of 20 bar with oxygen free dry nitrogen (OFDN) & close the cylinder valve when the gauge reading reaches 20 bar. For R410 it can be 43 bar.
- ☛ Apply a soap water or a liquid neutral detergent on the RAC system connection, joints and flares or outdoor unit connections by a brush to check for leakage.
- ☛ If bubbles come out, a leakage is indicated.

6. Evacuation & Vacuum holding

- ☛ To remove non-condensable gases (e.g. air) & moisture
- ☛ Deep vacuum important due to hygroscopic nature of polyol ester oil
- ☛ Two stage rotary vacuum pump - capable of developing blank off pressure of 20-50 microns, minimum capacity 2cfm
- ☛ Micron gauge capable of reading pressures in microns or other scales

7. Charging Refrigerant

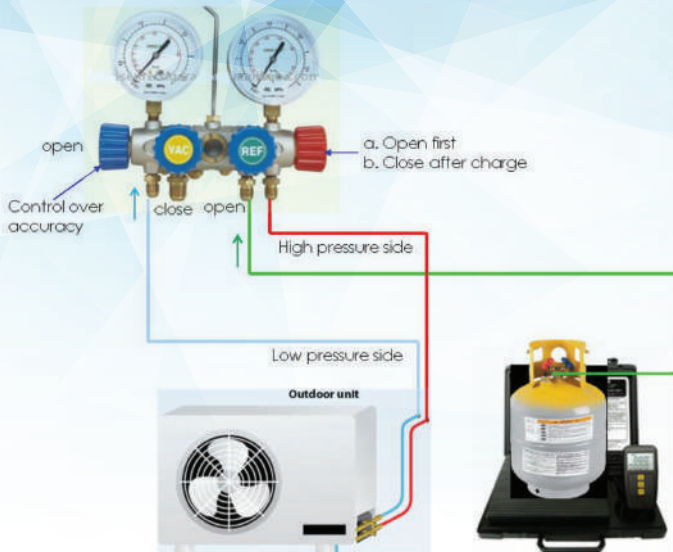

8. Sealing of process tube

- ☛ Braze (for window air-conditioner)
 - o Crimp (preferably twice)
 - o Do not remove crimping tool until tube is sealed
 - o Check for leaks
- ☛ Tightening of Valves (for split air-conditioner)
 - o Close the valve properly.
 - o Cap the valve
 - o Check for leaks

9. Checking for proper Operation

- ☛ Grill temperature
- ☛ Check compressor current
- ☛ Check no extra vibrations

Do's and Don'ts in Refrigeration & Air-Conditioning Servicing



Areas of Focus

- ☛ Good Tools
- ☛ Tube Cutting, Deburring
- ☛ Flare fitting
- ☛ Swaging
- ☛ Bending
- ☛ Brazing
- ☛ Cleaning and Flushing
- ☛ Leak Testing
- ☛ Evacuation
- ☛ Measurement / holding of vacuum
- ☛ Charging of Refrigerant
- ☛ Cross contamination

Tube Cutting

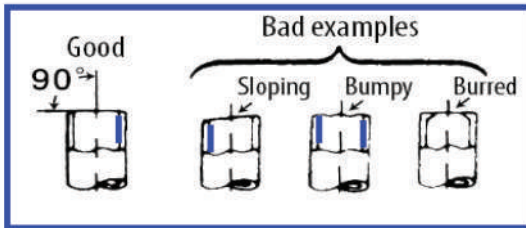

Pipe end shape of after cutting

Flare Fitting



Examples of bad flares	
Connection to a bad flare always leads to gas leaks, and so the flare should be recreated.	
Insufficient deburring	Cracked
A groove is formed	
Inner surface scratched by shavings, etc.	
Size of flare too small	
Size of flare too large	

Flaring - Best?

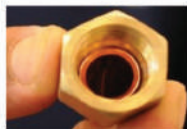

Bending



Manual bending of pipe



Bending by pipe bender

Air conditioning tubing v/s. plumbing tubing

SOME COMMON GRADES OF COPPER

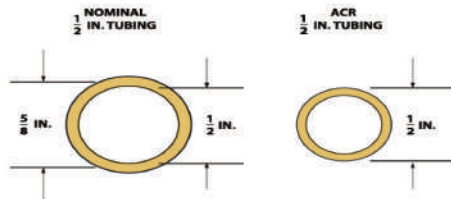

- K - Thick-walled copper piping used for heavy duty applications
- L - Medium-walled copper piping is the most frequently used
- M - Thin walled copper piping is rarely used in the HVAC industry

Temperatures for Brazing

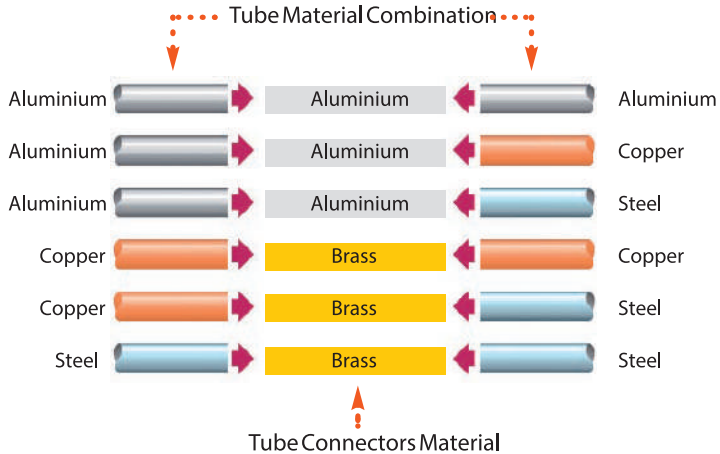
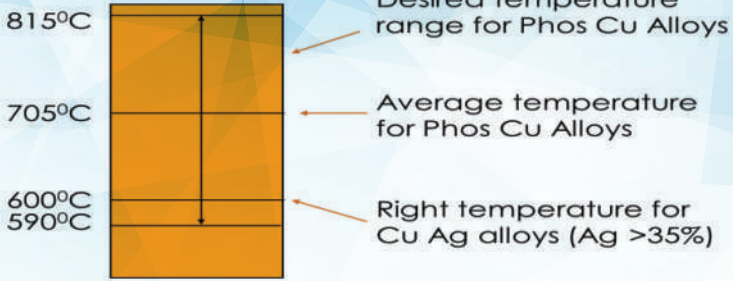

Equipment for Evacuation

DO NOT USE

- Refrigeration System's compressor
- Other Hermetic / Semi Hermetic / Open Refrigeration compressors

May lead to compressor failure as:

- moisture gets deposited in compressor's discharge chamber
 - there can be loss of lubricant
-
- Creates inadequate vacuum for moisture to boil and vacate the system

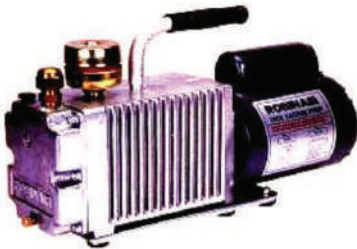

- ☛ Use specially designed vacuum pumps, capable of developing blank off pressure of 20 - 50 microns Hg
- ☛ Micron gauge capable of reading pressures in 5 - 5000 Microns range

Measuring Vacuum Accurately

- ☛ Use Thermocouple vacuum gauge having a range from 5-5000/10000 microns
- ☛ Evacuate to about 500 microns or lower
- ☛ Isolate the vacuum pump & observe the rise in the vacuum for 5-10 minutes
- ☛ Repeat (a) & (b) till the vacuum in (b) stabilizes at around 1500 microns or lower.

Charging

- ☛ The best method of charging is charge by weight.
- ☛ Charge the same weight of refrigerant in the system, as recommended by the appliance manufacturer instead of charging by feel or back pressure. (To ensure good cooling performance and low energy consumption)
- ☛ Charging apparatus must provide for accurate weighing scales or calibrated charging cylinders

Contamination & Cross Contamination

Contamination by :

- ☛ Moisture
- ☛ Non-condensable
- ☛ Chemical residues
- ☛ Dirt, dust metal particles
- ☛ Organic contaminants

Cross-Contamination through:

- ☛ Import of contaminants from other systems or servicing equipment

Contaminants:

- ☛ Other refrigerants, other lub. Oils, chemical residues from other systems

Likely Sites for Refrigerant Cross-Contamination

- ☛ Charging stills of Evacuation & Charging (E&C) units, used for multiple refrigerants
- ☛ Recovery & Recycling machines used for multiple refrigerants
- ☛ Recovery cylinders
- ☛ Hoses & Manifolds

How to avoid Refrigerant Cross-Contamination

- ☛ Ensure that all traces of the previous refrigerants is removed from the charging still / recovery machine & the unit is evacuated to a deep vacuum (1000 microns) before switching to a new refrigerant
- ☛ If possible use separate Evacuation & Charging (E&C) and Recovery machines for each type of refrigerants
- ☛ Use separate recovery cylinders for each refrigerant

Contributions to Climate Change from Air-Conditioners

- o Over the entire life cycle of the RAC equipment, considerable amounts of electricity will be consumed
- o Carbon-intensive electricity production. emissions can be around 1kg of Carbon-dioxide (CO₂) per kilo-wTT-HOUR (KWH).



Refrigerant Emissions:

Installation/Servicing + Leaks + Failures + End of Life

1 kg R-22	=	1,820 kg CO ₂
1 kg R-134a		1,300 kg CO ₂
1 kg R-410A		1,730 kg CO ₂
1 kg R-404A		3,260 kg CO ₂



CO₂ Emissions from Generating Electricity



CO₂ emissions are due to energy generated to run heating, refrigeration and air conditioning equipment

- HFC based refrigerants are the leading refrigerants those are currently consumed in the RAC service sector such as R-134a, R-410A, R-404A, R-407A, R-507A etc....
- Those refrigerants are greenhouse gases. Above figure shows that CO₂ equivalent for different type of HFC based refrigerants. Conserve refrigerants reduce CO₂ emissions and therefore prevent increasing global temperature.
- Emission of 01Kg of R-22 refrigerant is equal to emission of 1820 Kg of CO₂
- Emission of 01Kg of R-134a refrigerant is equal to emission of 1300 Kg of CO₂
- Emission of 01Kg of R-410a refrigerant is equal to emission of 1730 Kg of CO₂
- Emission of 01Kg of R-404A refrigerant is equal to emission of 3260 Kg of CO₂

As a Party to the Montreal Protocol on Substances that Deplete the Ozone Layer, Sri Lanka has to implement the following phase out schedule for importing R-22 (HCFC-22) refrigerant. According to this schedule, Baseline level for Sri Lanka for R-22 is 236mt (average imports of 2009 and 2010).

Import of this quantity will be reduced gradually as per the phase out schedule. It is important to note that only eligible importers are allowed to import R-22 refrigerant. Imports of R-22 refrigerant are not permitted after 31/12/2029.

Global Phase out Schedule for HCFC based Refrigerants for Developing Countries

Schedule	Sri Lanka Target
Average 2009-10 imports	Baseline level
January1,2013	Freeze at baseline
January1,2015	10% below baseline
January1,2020	35% below baseline
January1,2025	67.5% below baseline
January1,2030	100% Phase out

Similarly, Sri Lanka has to implement the following phase down schedule for importing HFC based refrigerants such as R-134a, R-410A, R-407A, R-32, R-507A under implementation of the Kigali Amendment to the Montreal Protocol.

Sri Lanka is categorized as a middle ambient temperature country and therefore, 2020, 2021 and 2022 are considered as the baseline years and country allowable country quota will be calculated based on those year imports. HFC based chemicals are not depleting the stratospheric ozone but those are greenhouse gases and therefore, contributed for global warming.

Global Phase down Schedule for HFC based Refrigerants for Developing Countries

	Developed Countries	Developing Countries Group 1 (Middle Ambient Temp)	Developing Countries Group 2 (High Ambient Temp)
Baseline years	2011-2013	2020, 2021&2022	2024, 2025 & 2026
Formula	Average HFC consumption	Average HFC Consumption + 65% of HCFC baseline production /consumption	Average HFC Consumption + 65% of HCFC baseline production /consumption
Freeze		2024	2028
1 st Step	2019 -10%	2029-10%	2032-10%
2 nd Step	2024- 40%	2035 -30%	2037 - 20%
3 rd Step	2029 -70%	2040- 50%	2042 -30%
4 th Step	2034 -80%	2045- 80%	2047 - 85%
Plateau	2036	2045	2047

Vapour absorption refrigeration

Common absorption refrigerators use a refrigerant with a very low boiling point (less than $-18\text{ }^{\circ}\text{C}$ ($0\text{ }^{\circ}\text{F}$)) just like compressor refrigerators. Compression refrigerators typically use an HCFC or HFC, while absorption refrigerators typically use ammonia or water and need at least a second fluid able to absorb the coolant, the absorbent, respectively water (for ammonia) or brine (for water). Both types use evaporative cooling: when the refrigerant evaporates (boils), it takes some heat away with it, providing the cooling effect. The main difference between the two systems is the way the refrigerant is changed from a gas back into a liquid so that the cycle can repeat. An absorption refrigerator changes the gas back into a liquid using a method that needs only heat, and has no moving parts other than the fluids.

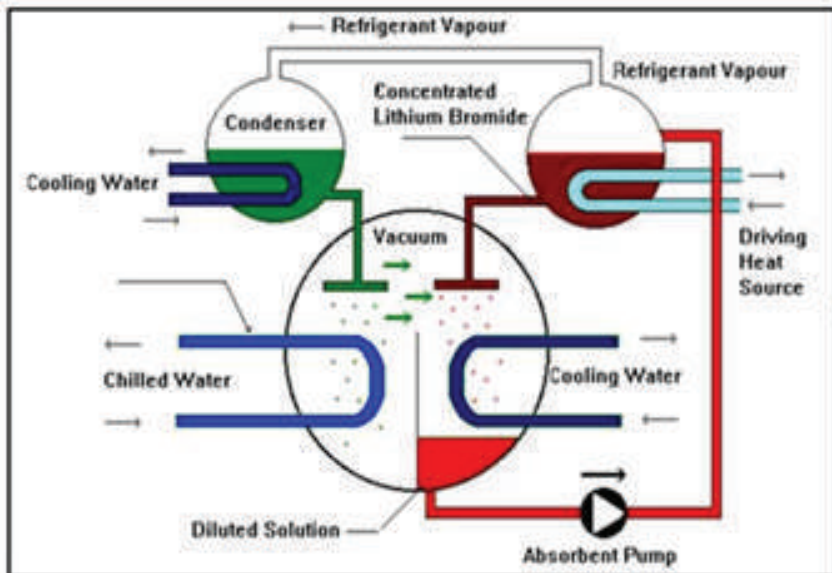

Cascade System

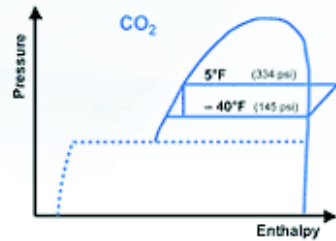
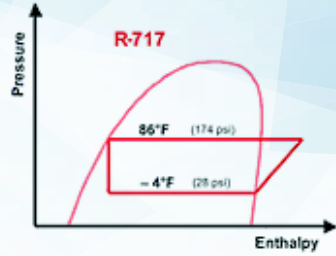
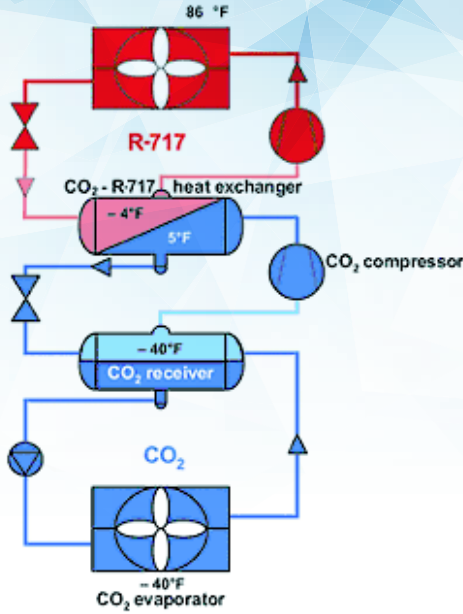

Old Cable Colour Code		
	Single Phase	Three Phase
Phase Conductor (Line)	Red or Yellow or Blue	Line 1 Red Line 2 Yellow Line 3 Blue
	Black	Black
	Green-and-Yellow	Green-and-Yellow

New Cable Colour Code		
	Single Phase	Three Phase
Phase Conductor (Line)	Brown	Line 1 Brown Line 2 Black Line 3 Grey
	Blue	Blue
	Green-and-Yellow	Green-and-Yellow

Start-Up Data Sheet			
Technician name			
Address			
Telephone & fax no.			
Registration no.			
Installation / Appliance DATA			
Type of installation		Model and no.	
Date started		Date finished	
Operating Data			
Refrigerant type		Refrigerant charge	
Type of lubricant		Lubricant charge	
Suction pressure P1		Condensing pressure P2	
Suction pressure evap. P3			
Discharge temp. T1		Hotgas temp. T2	
Air temp. ent. cond. T3		Air temp. leav. cond. T4	
Temp. ref. leav. cond. T5		Temp. liquid ent. filter T6	
Temp. ref. leav. filter T7		Air temp. ent. evap. T8	
Air temp. leav. evap. T9		Temp. gas leav. evap. T10	
Temp. gas ent. comp. T11			
LP-switch cut-off		HP-switch cut-off	
Electrical Data			
Power supply (voltage)	L1	L2	L3
Overall ampere reading	L1	L2	L3
Current draw compressor	L1	L2	L3
Current draw fan evapor.			
Current draw fan cond.			
Other Installation Data			
Discharge line diameter		Discharge line length	
Liquid line diameter		Liquid line length	
Suction line diameter		Suction line length	
Insulation suction line		Altitude diff. compr./evap.	
Type of condenser		Type of evaporator	
Type of filter-drier		Type and size of receiver	
Remarks:			
Signature technician			
Date			

Refrigeration System Retrofit Data Sheet			
Service Company Name			
Address			
Telephone & Fax No.			
Registration No.			
Client Name			
Address			
Telephone & Fax No.			
Contact Person Name			
Installation / Appliance DATA			
Type of Installation		Manufacturer	
Model and No.		Serial No.	
Type of Compressor		Manufacturer	
Model and No.		Serial No.	
Operating Data			
	Old		New
Refrigerant Type		Refrigerant Type	
Refrigerant Charge		Refrigerant Charge	
Type of Lubricant		Type of Lubricant	
Lubricant Charge		Lubricant Charge	
Suction Pressure		Suction Pressure	
Discharge Pressure		Discharge Pressure	
Suction Line Temp.		Suction Line Temp.	
Discharge Line Temp.		Discharge Line Temp.	
Ambient Temperature		Ambient Temperature	
Room / Medium Temp.		Room / Medium Temp.	
LP Cut-Off		LP Cut-Off	
HP Cut-Off		HP Cut-Off	
Electrical Data			
Power Supply (Voltage)		Power Supply (Voltage)	
Current Draw Compressor		Current Draw Compressor	
Other Installation Data			
Discharge Line Diameter		Discharge Line Length	
Liquid Line Diameter		Liquid Line Length	
Suction Line Diameter		Suction Line Length	
Insulation Suction Line		Altitude diff. Compr./Evap.	
Type of Condenser		Type of Evaporator	
Type of Filter-Drier		Type of Filter-Drier	
Signature Technician	Date	Signature Client	Date

Refrigeration system retrofit data sheet

Auto Air Conditioning System

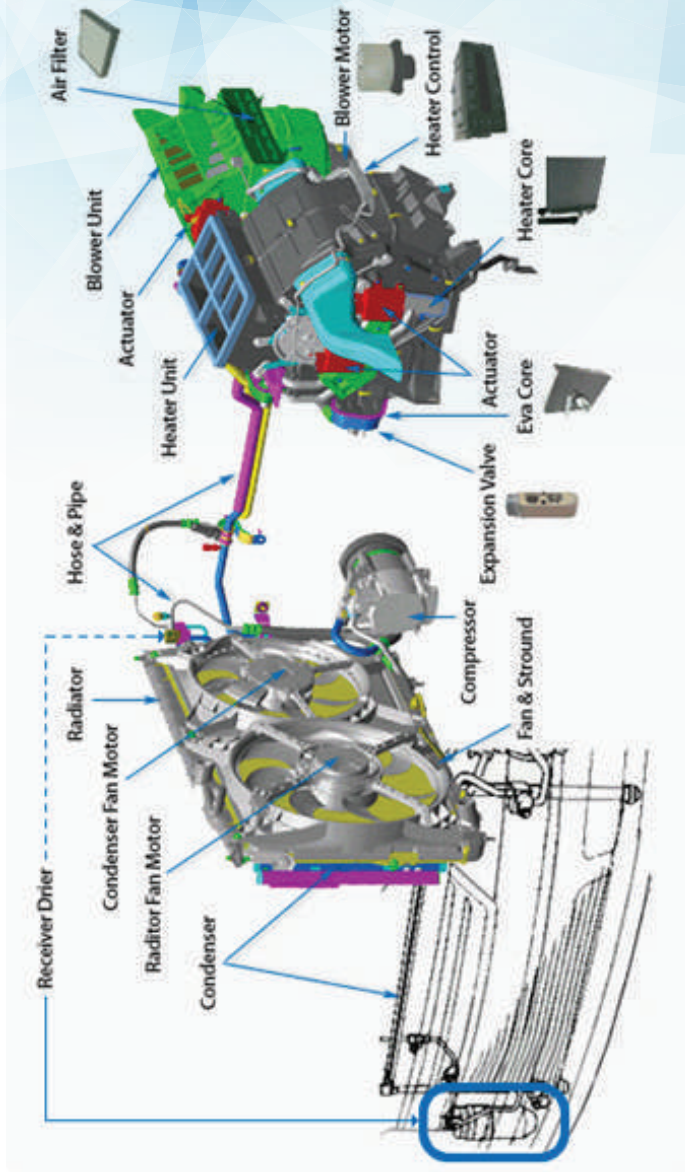

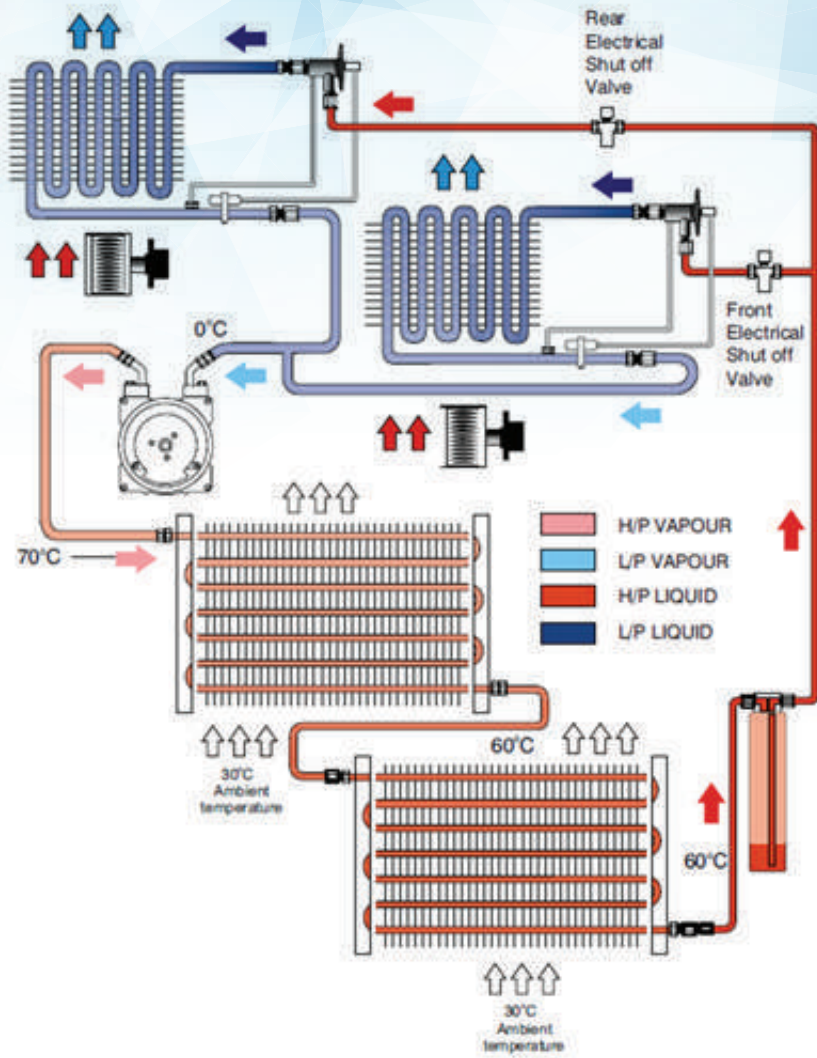

Schematic diagram of dual Auto air- conditioner system

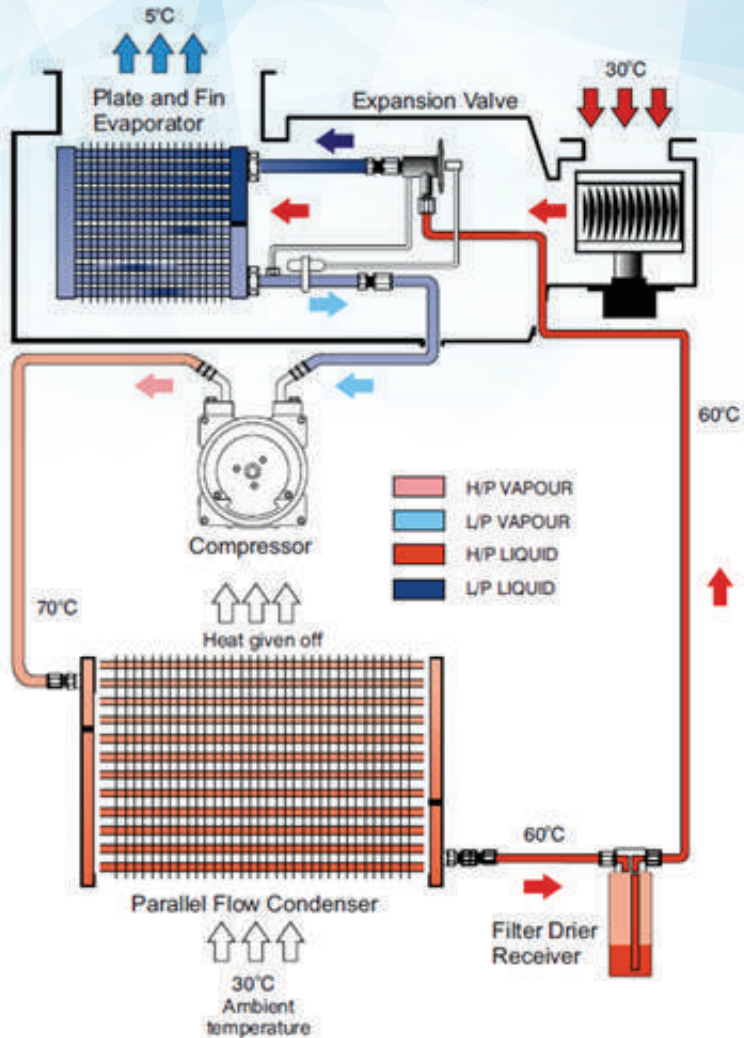

Schematic diagram of single Auto air-conditioner system

Compressor

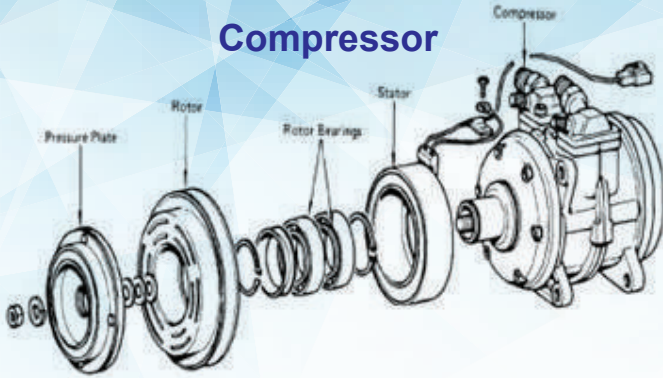

Expansion Valve



Internal equalizer type

External equalizer type

Condenser Types

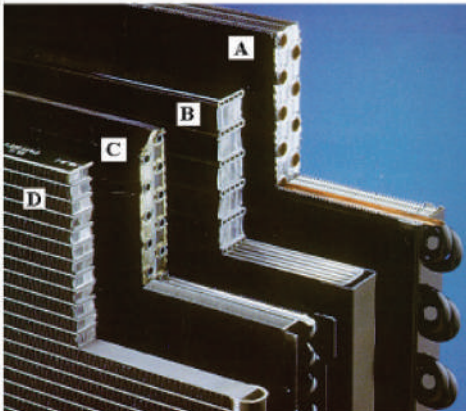

Condensers A and C are round tube, serpentine condensers.

Condenser B is an oval flat tube, serpentine condenser.

Condenser D is an oval flat tube, parallel flow condenser.

Flat tube condensers are more efficient.

Auto AC Evaporator

